

# 2.4GHZ Puck Antenna Specification

MODEL NO.:RY-2.4GHZ-17



## ( 1 ) Product Overview

Frequency (MHz) : 2400-2500

Bandwidth (MHz):100

VSWR  $\leq$  2:1

Gain (dBi) : 2

Polarization: Vertical

Power Capacity (w):50

Input Impedance ( $\Omega$ ) : 50

Housing colour: black

Housing Material:ABS

Cable length:0.1-5m RG174

Cable Connector:SMA Male,etc

Mounting type:Screw

Storage Temperature: -30°C to+75°C

Operating Temperature: -30°C to+75°C

IP Rating:IP65

## (2) Antenna size

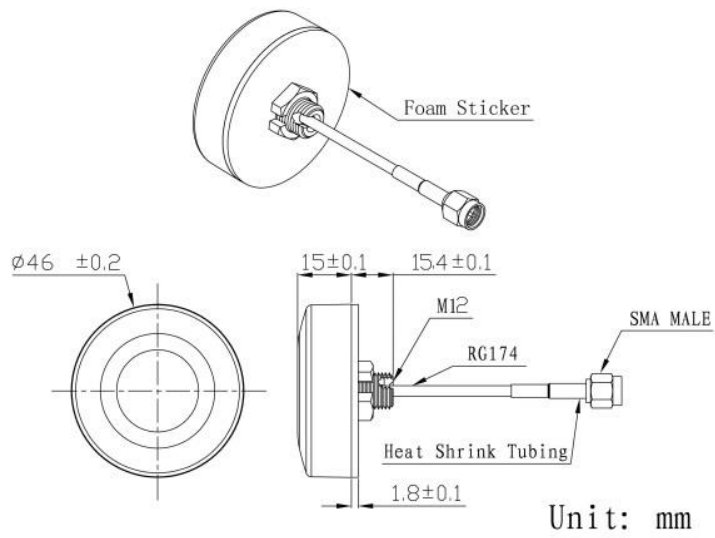

## (3) Testing Curve

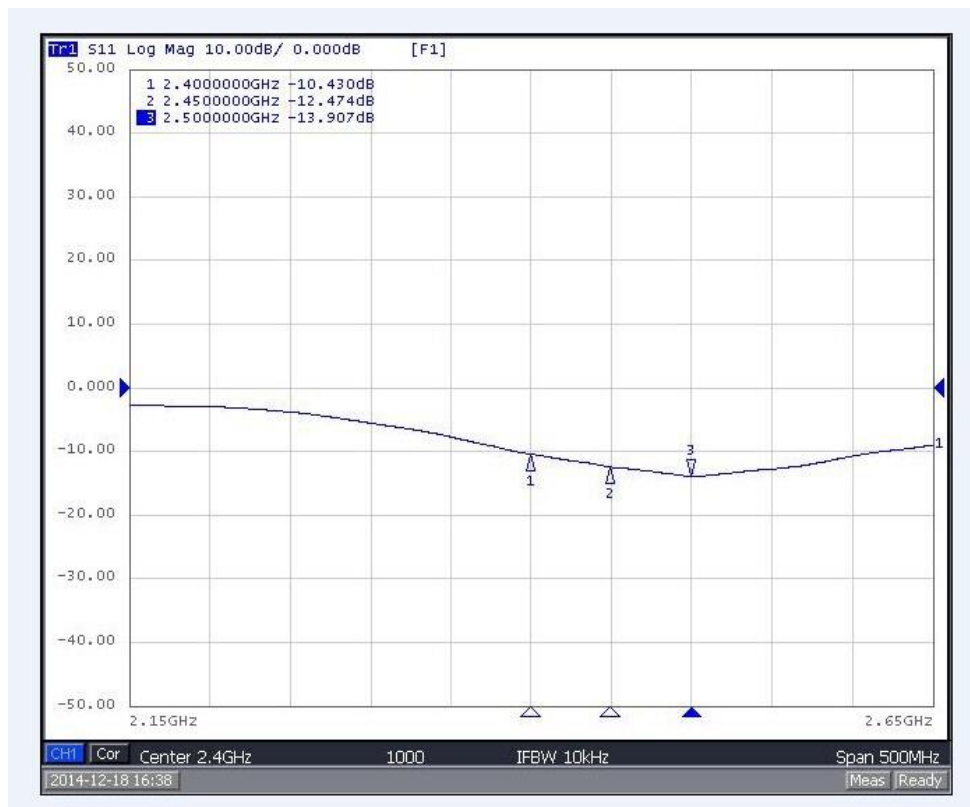

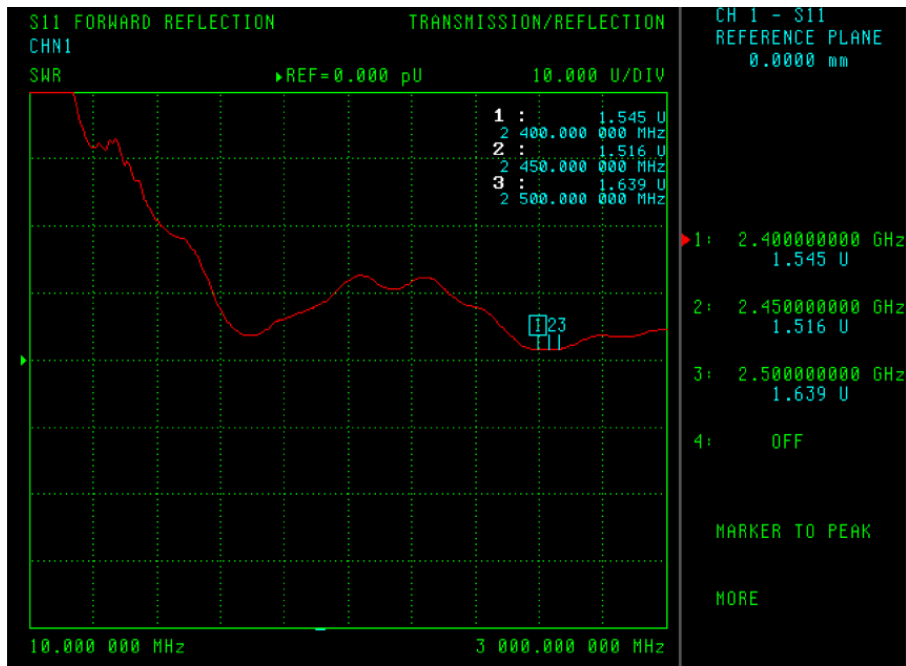

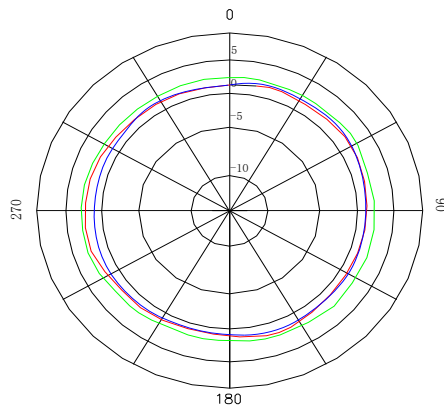

2. 4G天线极化图



水平面方向图(2.4G天线)  
Horizontal Pattern

	FRE (MHz)	Max dBi	Min dBi
	2400	2.75	2.11
	2450	3.03	2.68
	2500	2.56	1.67

2400MHz

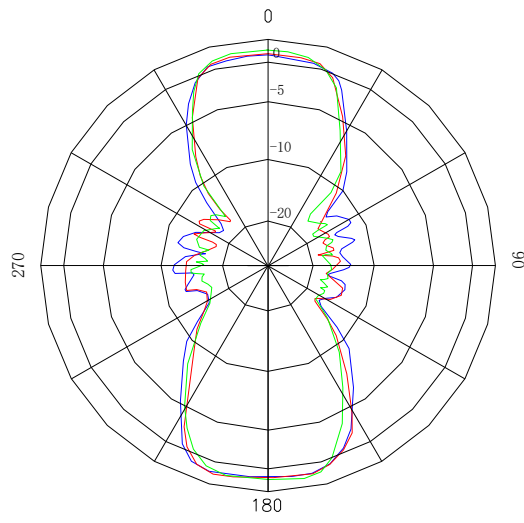

垂直面方向图  
Vertical Pattern

- 2400MHz
- 2450MHz
- 2500MHz